

Hi-Lo Mono 500 Heavy Duty Trolley - 8400

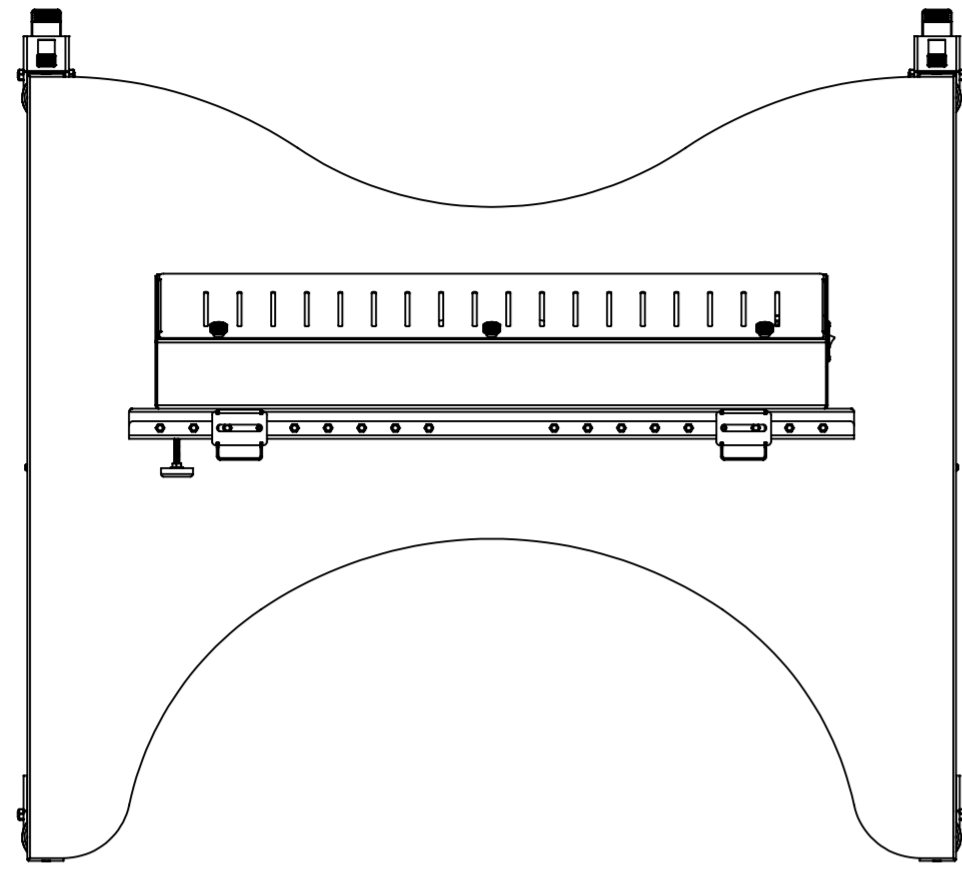

42-98" Screens

Max capacity 150kg

500mm Electric height adjustment  
(1035 - 1535mm)

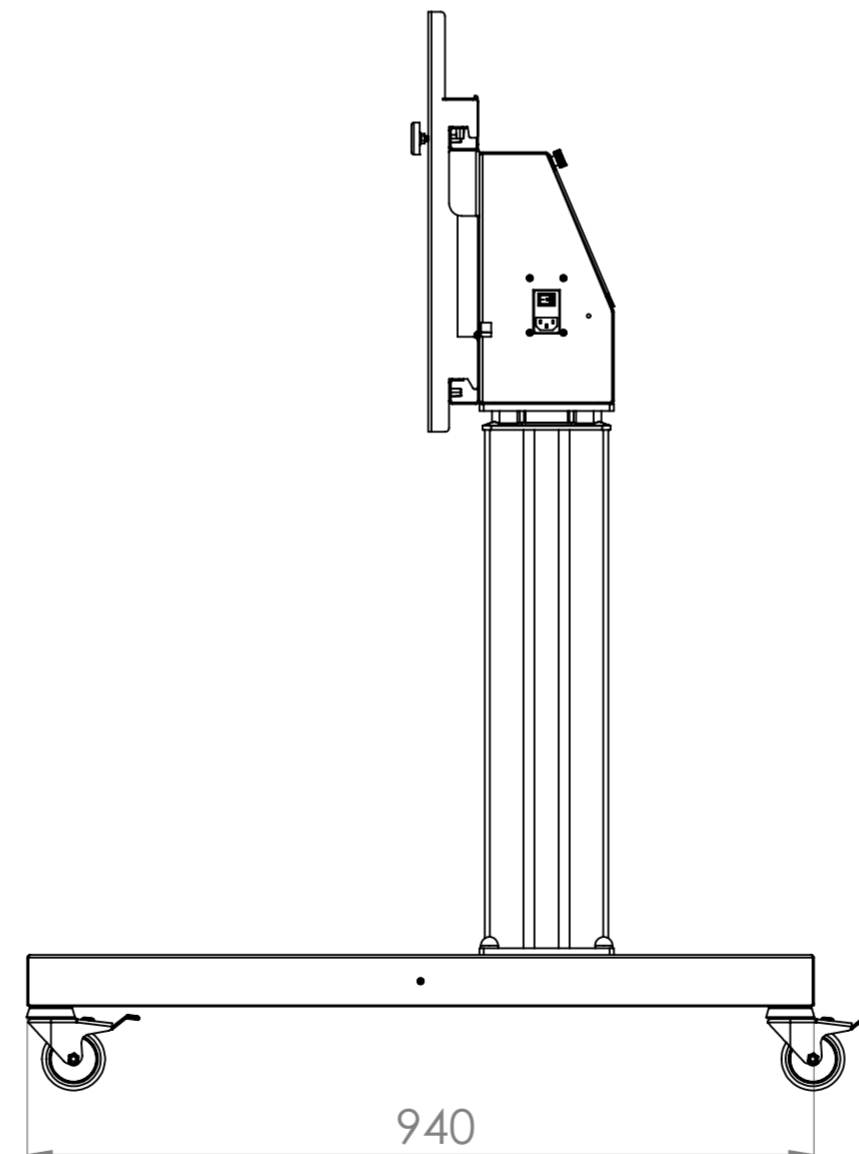
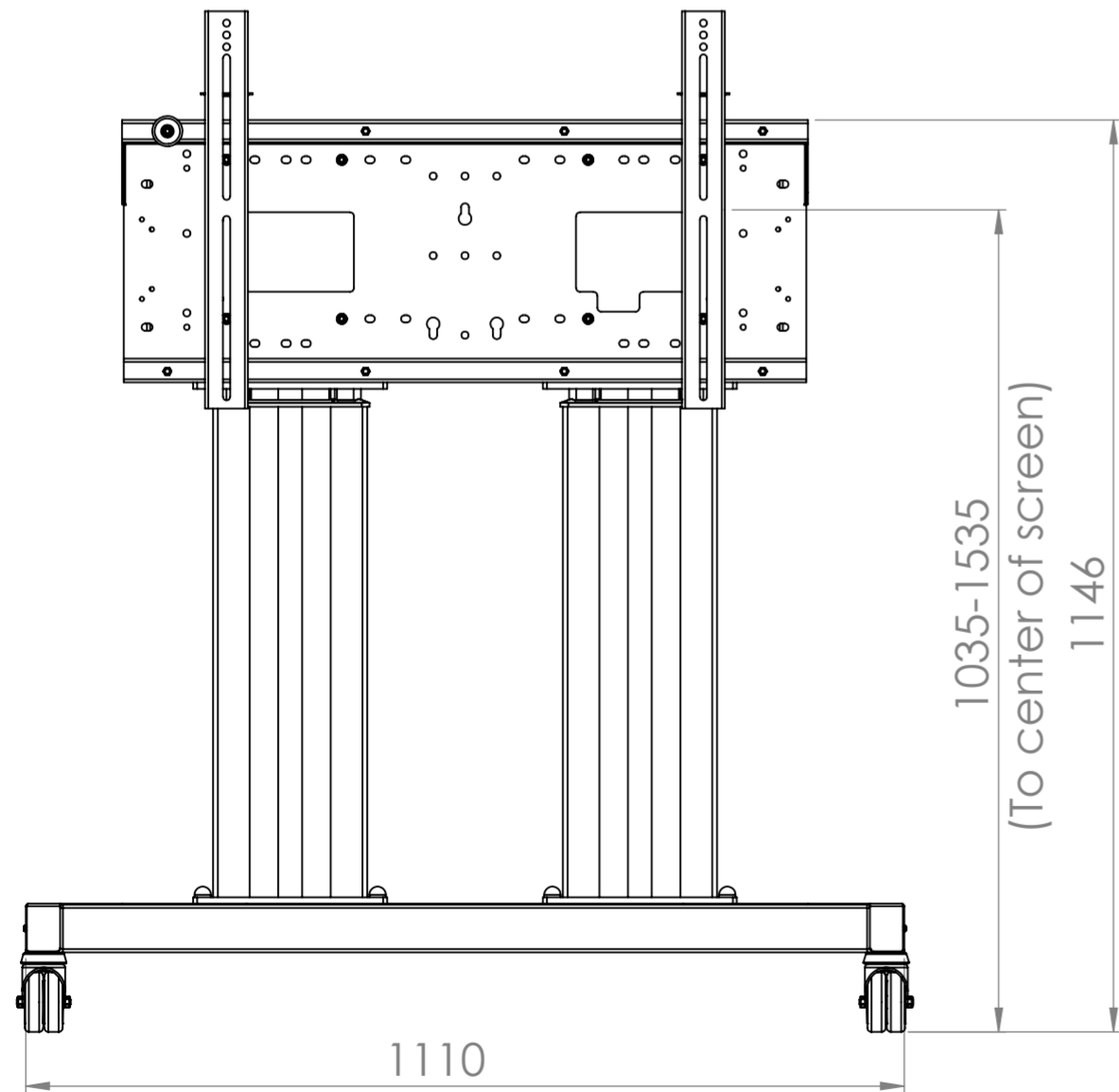
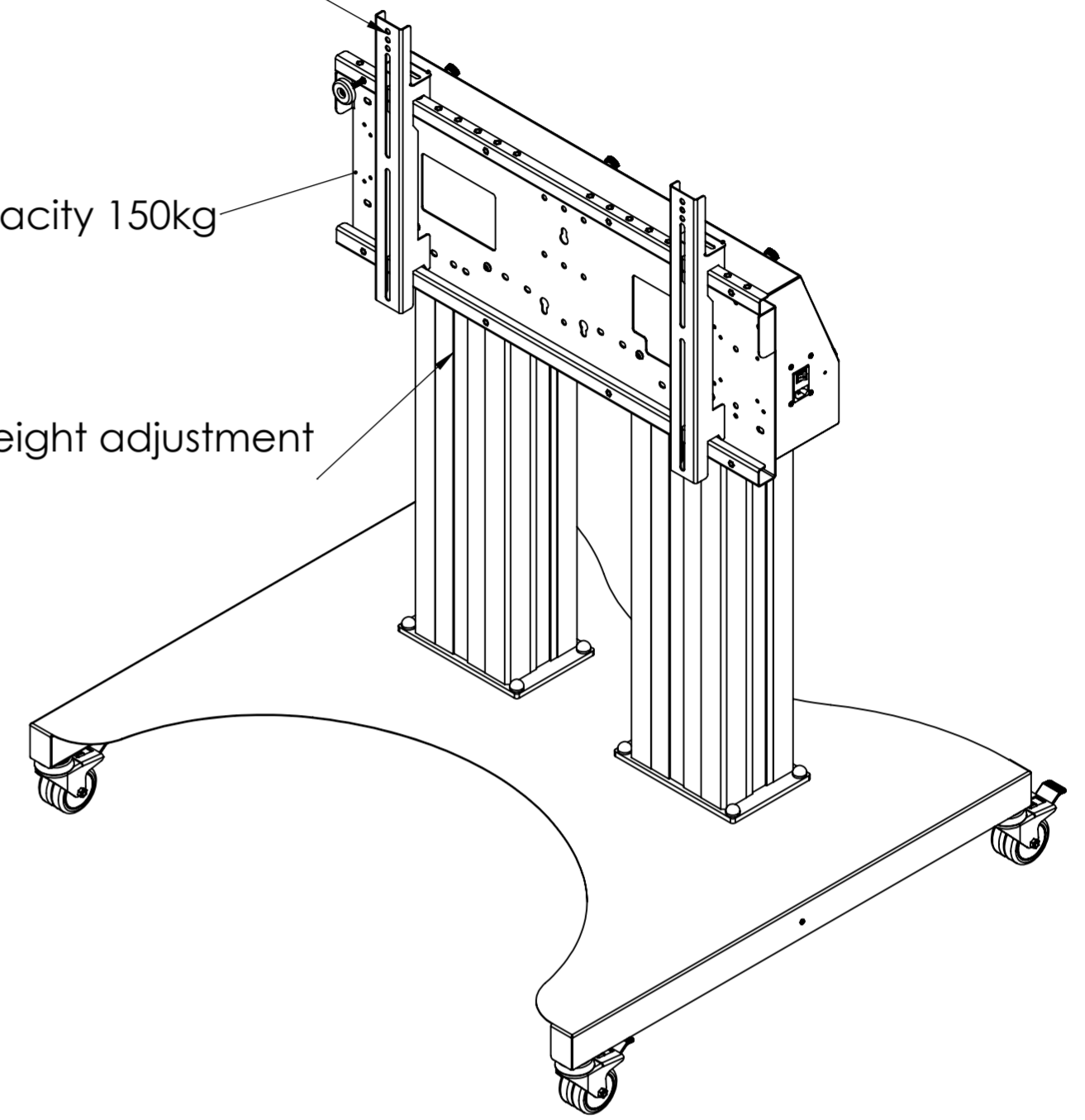

**LOXIT**  
PRODUCTS

**Loxit Limited**  
First avenue  
Poynton Industrial Estate  
Poynton  
Cheshire  
England  
SK12 1YJ  
t: +44 (0) 845 519 5191  
w: [www.loxit.com](http://www.loxit.com)

The copyright of this drawing is retained by Loxit limited  
This drawing may not be reproduced without prior written permission of Loxit limited

\*Dimensions given to a tolerance of +-3mm